

# Linear actuator V3M (Medical version)



## TECHNICAL SPECIFICATIONS

Motor type	24 Volts DC or 12 Volts DC
Push capability	maximum 1000 N
Pull capability	maximum 1000 N
Static load	maximum 2500 N
Speed	-maximum 44 mm/sec. unloaded -maximum 5.5 mm/sec. loaded at 1000 N
Sealing protection	IP54
Gear ratio	5 :1 / 10 :1 / 20 :1 / 30 :1 / 40 :1
Control boxes compatibility	compatible with all models of Umec control boxes
Operating temperatures	-25° to +65°
Duty cycle	25% (1 mn operation / 4 mn rest)
Colour	Grey aluminium
Standards certification	Medical Device directive 93/42/EEC (EN60601)

### Options :

Direction of motor-side clevis	0° or 90°
Fixing	-clamp connector -mounting bracket
Sealing protection	IP65
Analog positioning feedback	potentiometer
Positioning signal feedback	1 or 2 hall effect sensors

# PERFORMANCES

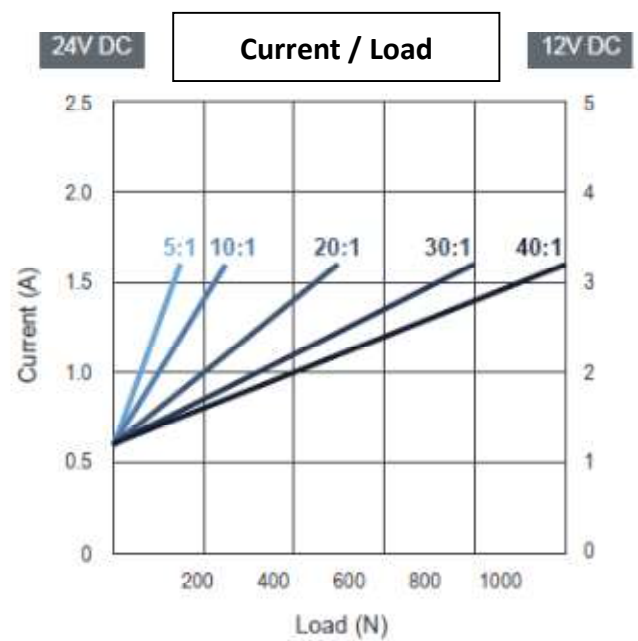
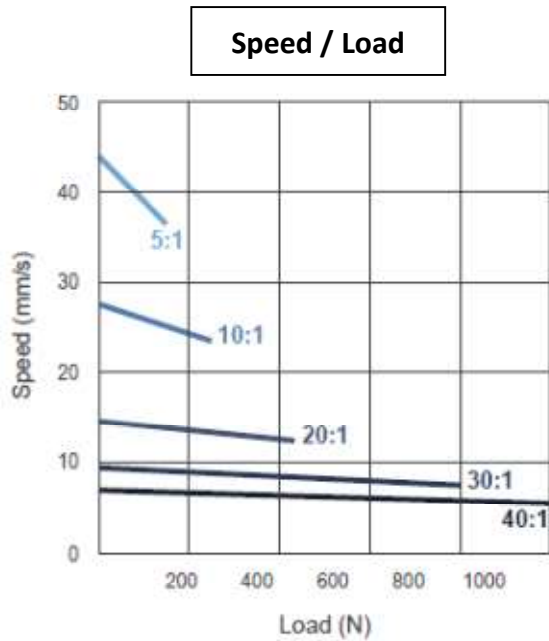

Gear ratio	Push / Pull Max. (N)	Self-locking force Max. (N)	Typical Speed (mm/s)		Typical Current (A)				Noise level (dB)
			No load	Full load	No load		Full load		
					24V	12V	24V	12V	
5:1	150	2500	43.9	36.5	0.6	1.2	1.6	3.2	≤ 70
10:1	250	2500	27.6	23.5	0.6	1.2	1.6	3.2	≤ 70
20:1	500	2500	14.6	12.3	0.6	1.2	1.6	3.2	≤ 70
30:1	800	2500	9.5	7.5	0.6	1.2	1.6	3.2	≤ 70
40:1	1000	2500	7.0	5.5	0.6	1.2	1.6	3.2	≤ 70

# STANDARD DIMENSIONS

• Basic

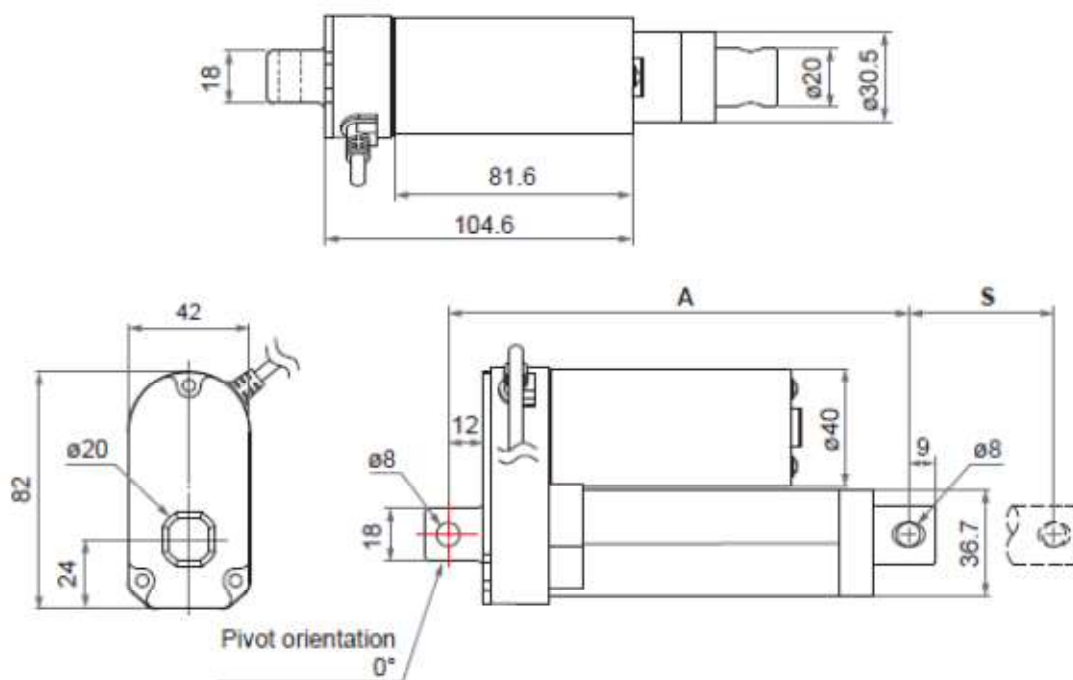

● With Potentiometer

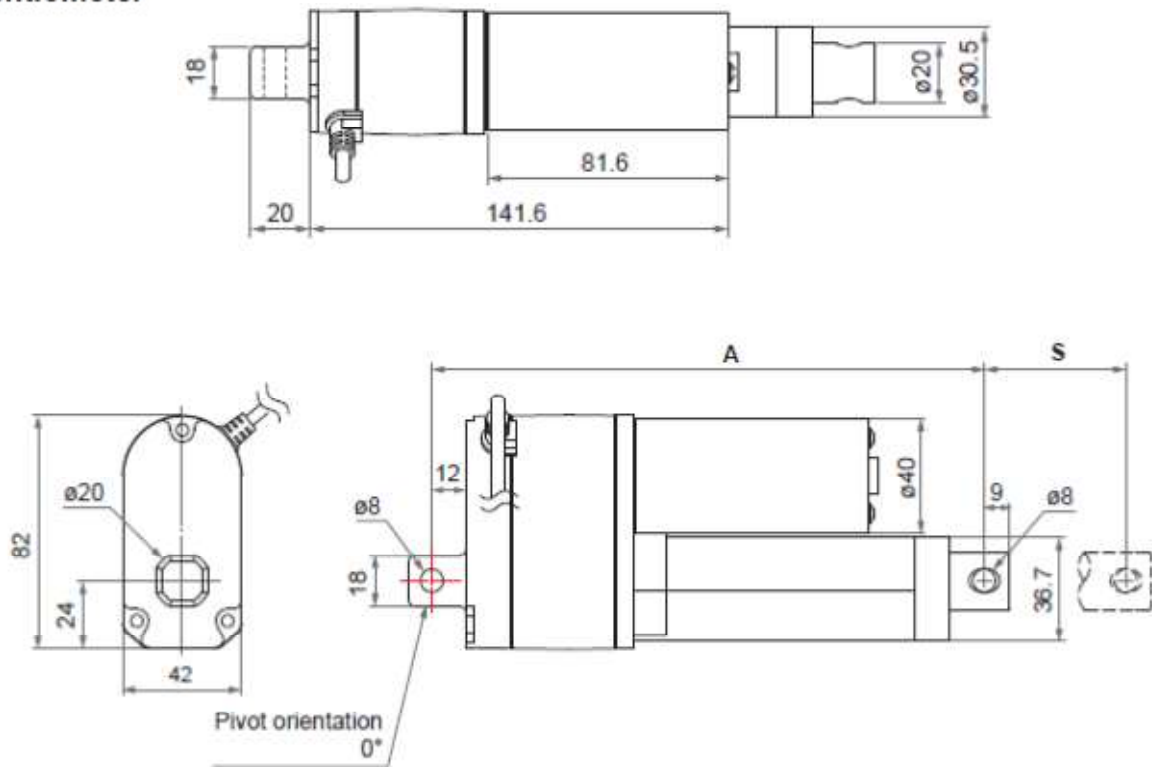

● Installation Dimension

Retracted length (A)

Option	Front connector code	Stroke (S)					
		50	100	150	200	250	300
Standard or Hall sensor	1, 4	158	209	260	311	362	413
	3	199	250	301	352	403	454
	6	168.5	219.5	270.5	321.5	372.5	423.5
POT	1, 4	195	246	297	348	399	450
	3	236	287	338	389	440	491
	6	205.5	256.5	307.5	358.5	409.5	460.5

(tolerance: ±3mm)

Note: other customized strokes available upon demand.

# FIXING CONNECTIONS

## • Front Connector

1: Drilled hole

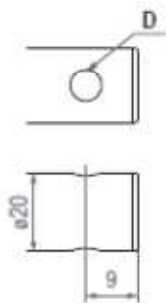

3: Spherical rod eye

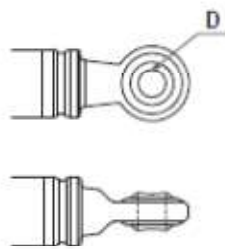

4: Plastic solid

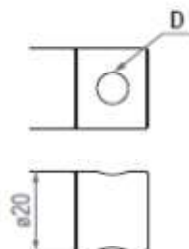

6: Plastic slot

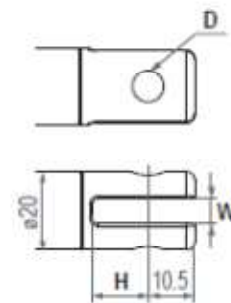

## • Rear connector

1: Zinc alloy clevis, 0°

3: Zinc alloy clevis, 90°

2: Aluminum alloy clevis, 0°

4: Aluminum alloy clevis, 90°

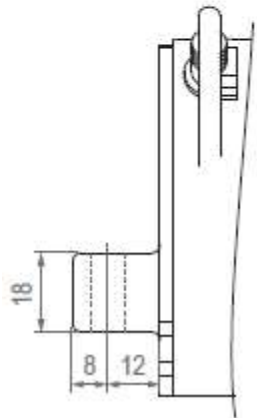
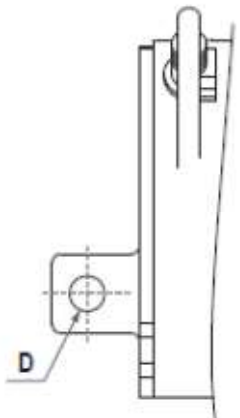
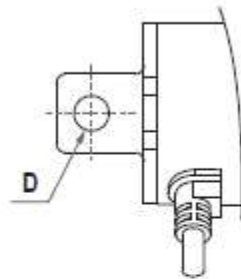
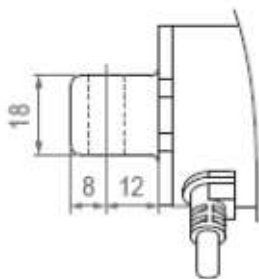

## • Clamp

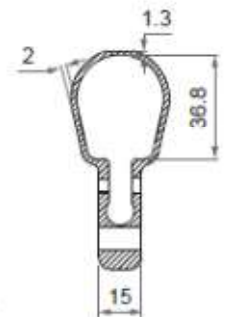
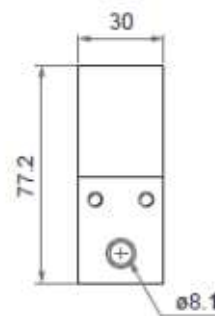

## • Mounting bracket (MB22)

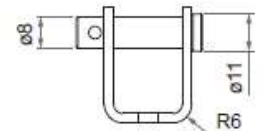
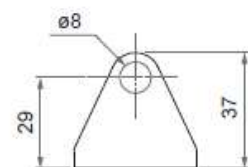
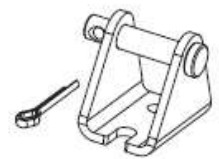
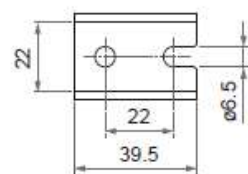

Front connector code	Diameter of pivot without bushing (D)	Slot width (W)	Slot depth (H)
1	ø6.4, ø8, ø10	N/A	N/A
3	ø8	N/A	N/A
4	ø8, ø10	N/A	N/A
6	ø8, ø10	6	15
Rear connector code			
1	Regular version: ø6.4, ø6.5, ø8, ø10 Quiet version: ø6.4, ø8, ø10	N/A	N/A
2			
3			
4			